

B

饮用水 含气饮料 乳品 果汁饮料
灌装包装

DRINKING WATER, AIR BEVERAGE, DAIRY,
FRUIT JUICE BEVERAGE, FILLING AND PACKAGING



上海威正达智能科技有限公司
Shanghai Victorystar Intelligent Technology Co.,Ltd

电话: +86 136 1178 1699
邮箱: jack@shvictorystar.com
网址: https://www.weystartech.com
地址: 上海市奉贤区
Contact: +86-136 1178 1699(Whastapp)
Email: jack@shvictorystar.com
Website: http://en.weystartech.com
Address: Fengxian District, Shanghai City, China



www.weystartech.com
www.en.weystartech.com

饮用水 含气饮料 乳品 果汁饮料
灌装包装

DRINKING WATER, AIR BEVERAGE, DAIRY,
FRUIT JUICE BEVERAGE, FILLING AND PACKAGING



B



C

OMPANY PROFILE 关于威正达企业

公司业务范围 / Company business scope

上海威正达智能科技有限公司是专业从事饮料工艺技术研发、设备制造、安装、调试、售后、技术服务于一体的企业，具有丰富的理论和工程实践经验。

强大的技术力量，精湛的工艺，认真的工作态度，完善的售后服务，是上海威正达智能科技有限公司事业发展的基石。目前公司产品不仅遍布国内，还远销东南亚、中东、欧洲、非洲等地区，以其先进性、新颖性和实用性获得国内外用户赞誉。

本公司常年与闻名院校、大学、研究所等多家国内机构合作，对水产品、茶饮料、果蔬汁、奶制品、含气饮料、发酵果酒、油、调味品及化工产品等各种液态或液、固混合态产品的前期调配、杀菌、洗瓶、灌装、封口、装箱以及相关配套设备等进行技术研发，同时引进国外食品机械先进制造技术，专业生产全自动调配系统、均质系统、CIP就地清洗系统、全自动控制等压、负压灌装设备，板式、管式UHT杀菌设备、纯净水处理全套生产设备、奶制品全套处理系统，酵素产品、气泡果汁(果酒)玻璃瓶及易拉罐灌装系统以及中温无菌灌装全套设备等。



Shanghai Victorystar Intelligent Technology Co.,Ltd. is specialized in beverage process technology research and development, equipment manufacturing, installation, commissioning, after-sales service and technical service in one enterprise, with rich theoretical and practical experience in engineering.

Strong technical force, exquisite technology, serious working attitude and perfect after-sales service are the cornerstones of the business development of Shanghai Victorystar Intelligent Technology Co.,Ltd. At present, our company's products not only spread all over the country, but also exported to Southeast Asia, Middle East, Europe, Africa and other regions, and won the praise of domestic and foreign users for its advancedness, novelty and practicality.

Our company has been cooperating with many domestic institutions such as famous colleges, universities, research institutes, etc., to develop technology for pre-blending, sterilization, bottle washing, filling, sealing, packing and related supporting equipment for various liquid or liquid-solid mixed products such as aquatic products, tea drinks, fruit and vegetable juices, dairy products, aerated drinks, fermented fruit wines, oils, condiments and chemical products, etc. Meanwhile, we have introduced advanced manufacturing technology of foreign food machinery. Our company specializes in the production of fully automatic blending system, homogenization system, CIP in-situ cleaning system, fully automatic control of isobaric and negative pressure filling equipment, plate and tube UHT sterilization equipment, full set of production equipment for pure water treatment, full set of treatment system for dairy products, glass bottle and can filling system for enzyme products, carbonated juice (fruit wine) and full set of equipment for medium temperature aseptic filling, etc.



04 纯净水/矿泉水生产线	Bottle water production line
05 碳酸饮料生产线	Carbonated drinks production line
06 果蔬汁饮料包装线	Fruit & vegetable juice packaging line
07 乳品包装线	Dairy packaging line
08 啤酒生产线	Beer production line
09 沙冰/冰淇淋生产线	Slush/ice cream production line
10 吹灌旋设备	Combi-block blowing-filling-capping machine
12 超洁净4合1灌装机	Ultra-clean 4-in-1 filling machine
13 冲瓶灌装旋盖三合一机组	Washing-filling-capping 3-in-1 machine
13 三合一常压热灌装机	Hot filling 3-in-1 machine
14 等压冲瓶灌装旋盖三合一机组	Isobaric washing-filling-capping 3-in-1 machine
14 玻璃瓶三合一灌装机	Glass bottle 3-in-1 filling machine
15 灌装铝箔封口机	Filling and foil sealing machine
15 直线灌装机	Linear filling machine
16 易拉罐灌装生产线	Can filling sealing machine
16 卸垛机	Empty can depalletizer
17 屋顶盒灌装机	Gable top carton filling machine
18 高速砖包无菌灌装机	High speed brick aseptic filling machine
19 全自动无菌软包装机	Automatic aseptic plastic pouch filling machine
20 无菌袋灌装机	Aseptic bag filling machine
21 自动桶装生产线	Automatic barreling production line
22 杯装灌装封口机	Cup filling sealing machine

CONTENTS 目录

22 液体包装机	Pouch packaging machine
23 单头/双头套标机	Sleeve labeling machine
24 不干胶贴标机	Sticker labeling machine
25 热熔胶贴标机	Hot melt glue labeling machine
26 全自动吹瓶机	Automatic bottle blowing machine
27 半自动吹瓶机	Semi-auto bottle blowing machine
28 倒瓶杀菌机	Automatic bottle tilting sterilizer
29 喷淋杀菌机	Continuous spraying tunnel pasteurizer
30 水浴杀菌机	Continuous water soaking pasteurizer
31 杀菌釜	Water spray retort
32 膜包机	Film shrink packing machine
33 装箱机	Carton packing machine
34 码垛机	Palletizer
35 缠绕膜机	Film wrapping machine





Bottle water production line 纯净水/矿泉水生产线



Carbonated drinks production line 碳酸饮料生产线

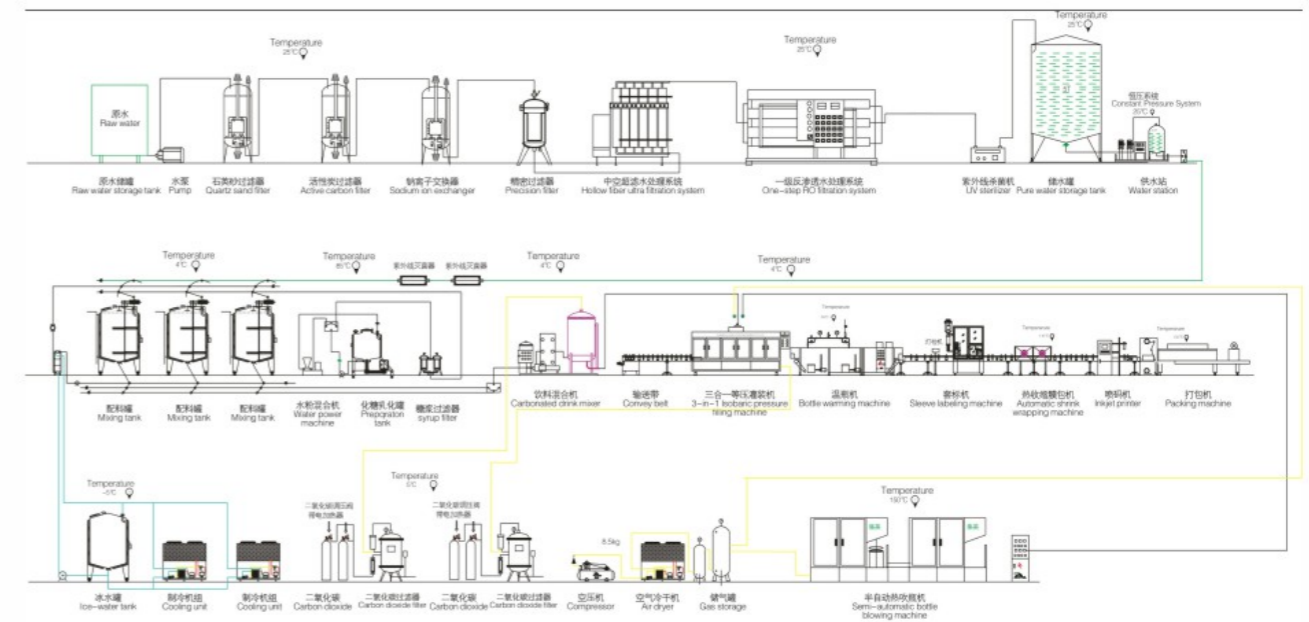
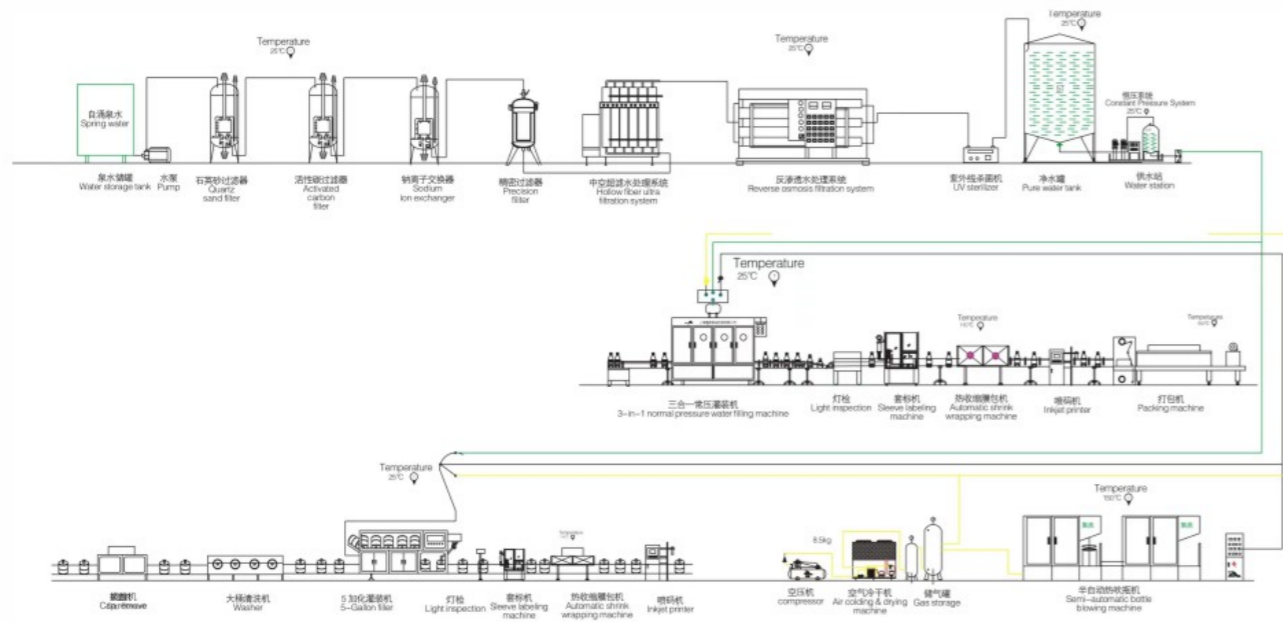



Fruit & vegetable juice packaging line 果蔬汁饮料包装线



Dairy packaging line 乳品包装线

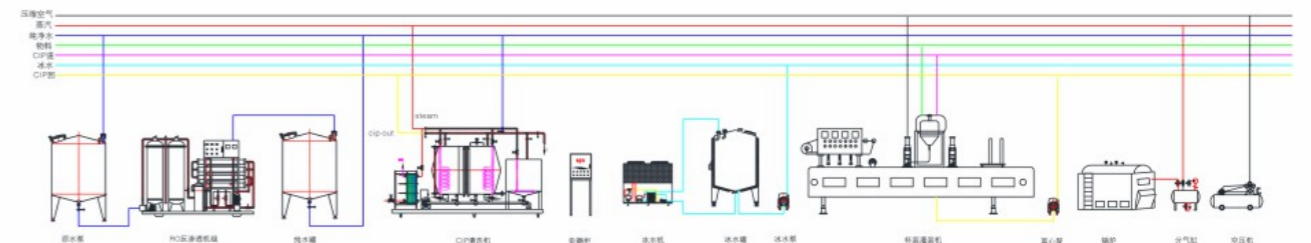
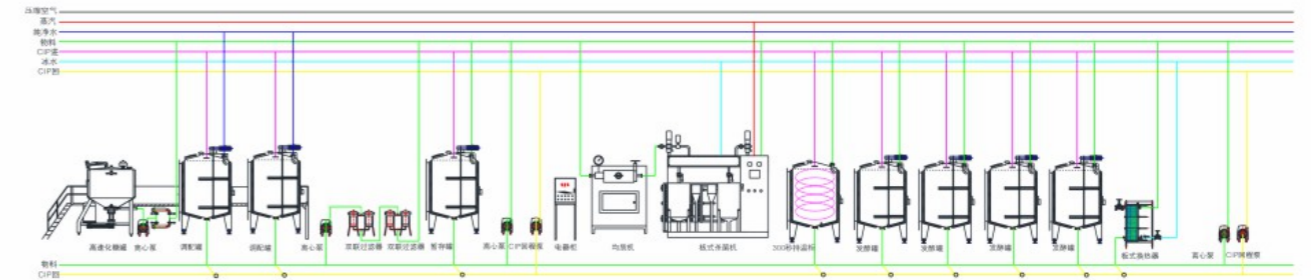
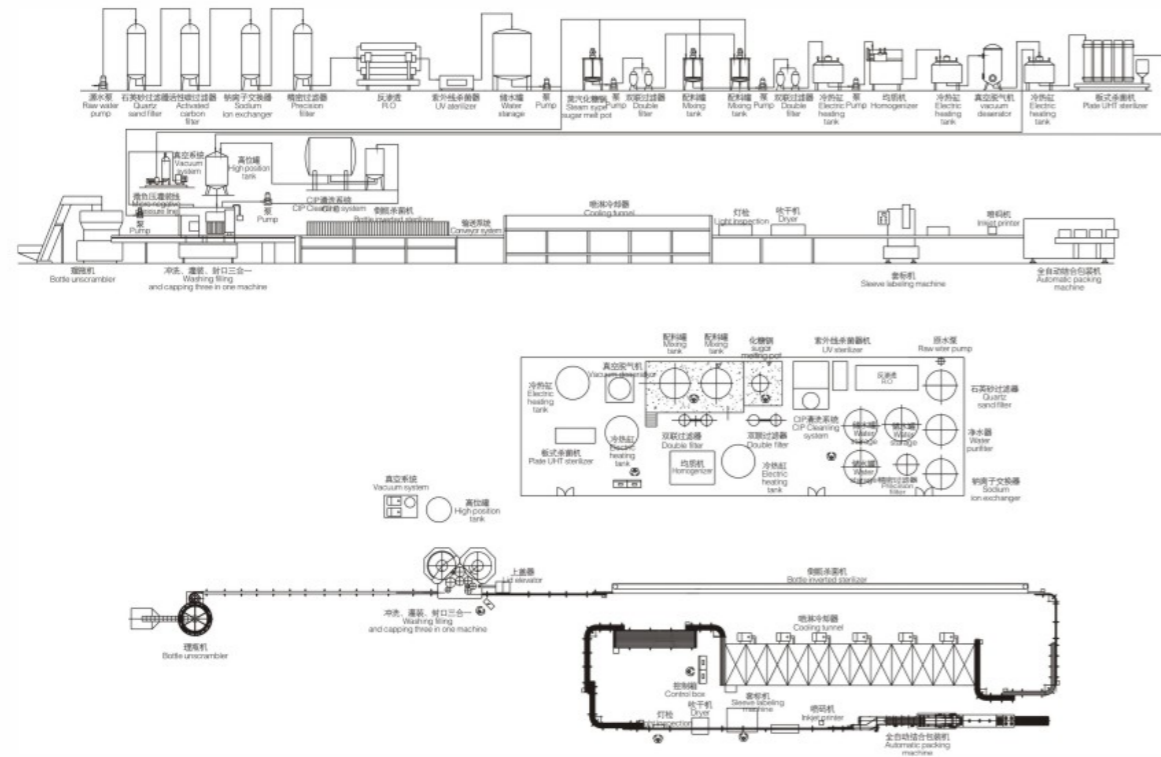

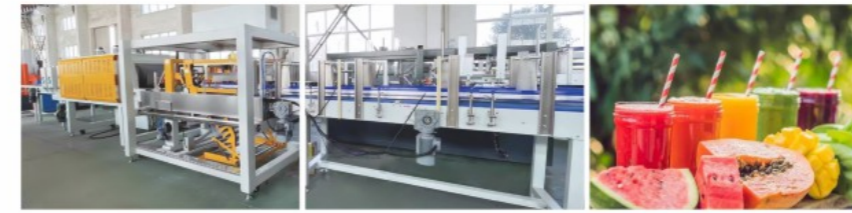

Beer production line 啤酒生产线



Slush/ice cream production line 沙冰/冰淇淋生产线

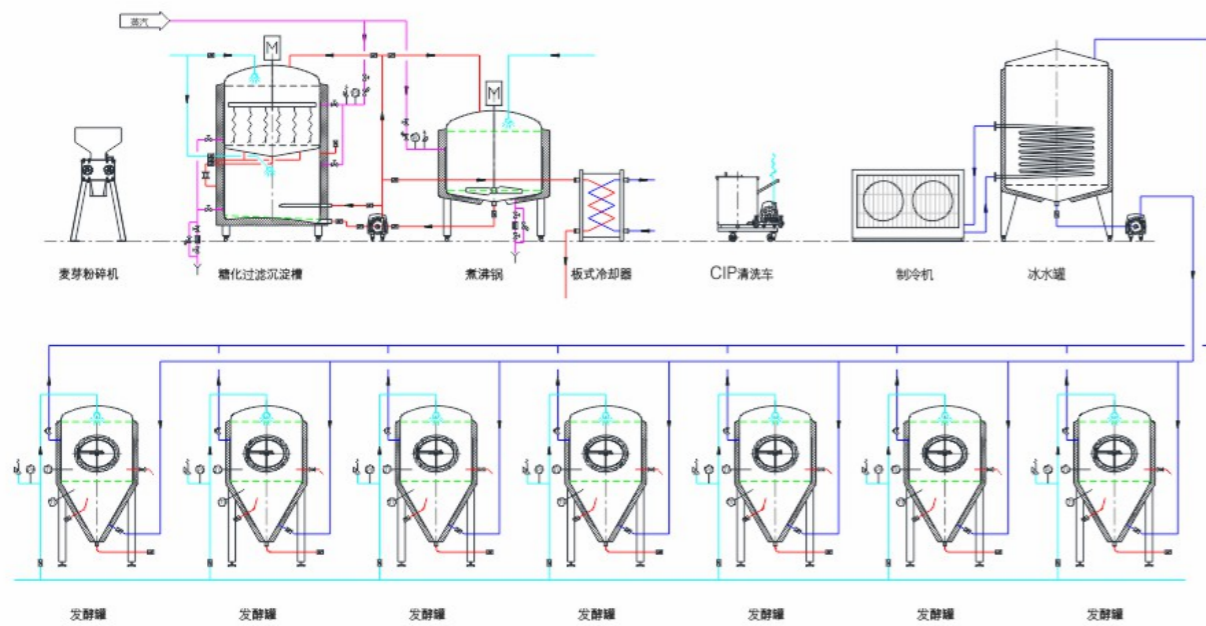



Combi-block blowing-filling-capping machine 吹灌旋设备

集吹瓶、灌装及旋盖解决方案于一体的集成系统，减少了传送、空瓶处理、堆积和存储工序等中间环节，改善了包装卫生条件、降低交叉污染，提高了整体运转效率，同时能耗大幅下降，从而降低饮料生产企业的综合生产成本。

The integrated system, which integrates blowing, filling and capping solutions, reduces intermediate links such as transfer, empty bottle handling, stacking and storage processes, improves packaging hygiene conditions, reduces cross-contamination, improves overall operating efficiency, and significantly reduces energy consumption, thus reducing the comprehensive production cost of beverage manufacturers.



产品适用范围

适用于PET瓶包装的饮用水、碳酸饮料、果汁、茶饮料。

Product scope

PET bottles for drinking water, carbonated drinks, fruit juice, tea and other beverages.

灌装定量方式

机械接触式，电子非接触式。

Filling quantitative method

Mechanical contact type, electronic non-contact type.

生产能力

15000瓶/小时~60000瓶/小时

Productive capacity

15000 bottles/hour ~ 60000 bottles/hour





Ultra-clean 4-in-1 filling machine 超洁净4合1灌装机

本系列设备用于聚酯瓶装各种纯净水、矿泉水等的生产，在一体机上实现冲瓶、灌装、封盖三个功能。整机设计科学合理，外形美观，功能齐全，操作维修方便，自动化程度高。本机综合采用意大利和德国的先进技术，灌装速度快，液面控制稳，采用风送进瓶。夹瓶口，冲瓶口，卡瓶口灌装，旋盖等部分不受瓶子高矮限制，只要瓶口、瓶盖相同可随意更换瓶形，更换一下拨轮板即可。本机组靠油尼龙齿轮传动，噪声小，运转平稳。其中旋盖部分采用磁力扭矩式拧盖头，实现抓盖拧盖一体功能。其中拧盖力矩无级可调，具有恒力矩旋封盖功能，且不伤盖，封口严密可靠。水平回转式气力理盖器，具有不损坏瓶盖表面，料斗内缺盖发信号自动补充盖子等功能。整机采用PLC电脑程序控制及人机界面触摸屏按钮，具有料缸内液面自动控制，无瓶不灌装，无瓶不加盖功能，并有拨瓶星轮卡瓶错位停机，盖滑槽内缺盖停机等功能。



This series of equipment is used for polyester bottles of all kinds of pure water, mineral water, etc., in one machine to achieve the three functions of punching bottle, filling, capping. The whole machine design is scientific and reasonable, beautiful appearance, complete functions, easy operation and maintenance, high degree of automation. The machine adopts the advanced technology of Italy and Germany, the filling speed is fast, the liquid level is controlled steadily, and the bottle is fed by the air. Clamping bottle mouth, punching bottle mouth, bottle mouth filling, capping and other parts are not limited by the height of the bottle, as long as the bottle mouth, the bottle cap can be changed freely, replace the wheel plate. The unit is driven by oil nylon gear with low noise and smooth operation. The capping part adopts the magnetic torque type capping head to realize the integrated function of grasping the capping and screwing the capping. The capping torque is stepless and adjustable, with constant torque capping function, and does not damage the cap, sealing tight and reliable. The horizontal rotary pneumatic cap trimmer has the functions of not damaging the surface of the cap and automatically replenishing the cap by signaling the missing cap in the hopper. The machine adopts PLC computer program control and man-machine interface touch screen button. It has the functions of automatic control of liquid level in the cylinder, no bottle filling, no bottle capping, dislocation stop of the bottle by the star wheel, and stop of the missing cover in the cover chway.



Washing-filling-capping 3-in-1 machine 冲瓶灌装旋盖三合一机组

本机主要用于饮料的灌装作业。本机将冲洗、灌装、封口三功能合在一个机体上，全过程实现自动化，适用于聚酯瓶、塑料瓶灌装矿泉水、纯净水。各部分的适用瓶型调整轻松自如，简便快捷。灌装方式采用了新型的微负压灌装，稳定可靠，所以与同规格的机器相比，本机的效益更大。本机采用了先进的OMRON可编程控制器(PLC)控制机器的自动运行，进瓶采用风送装置，输出瓶链道采用可调速方式，与主机变频器相互配合使出瓶运行更稳定可靠。光电检测各部件的运行状况，所以自动化程度高，操作简便。是饮料生产厂家理想的首选设备。

The machine mainly used in the beverage filling operations. The three functions of bottle washing, filling and capping are composed in one body of the machine. The whole process is automatic. The machine is used to fill mineral water and purified water in bottles made of polyester and plastics. The machine is conveniently turned to adjust the machine to fill various types of bottles. The filling operation is faster and more stable due to the micro-negative pressure filling operation of the new type is adopted. The output and benefit of the machine is higher than the machines of the same specifications. The advanced OMRON programmed controller (PLC) is adapted to control the machine runs automatically, air conveyor system is adopted in bottle entry section and belt conveyor system is adopted in bottle exit section, which can adjust speed and coordinated with transducer of the main machine to make the output of moving bottle forward steadily and reliably. It is convenient to operate with higher automation due to every parts of the machine which is inspected to run with photo electrical detector. The machine is ideal-preferred equipment for beverage makers.



Hot filling 3-in-1 machine 三合一常压热灌装机组

本机用于绿茶、红茶、乌龙茶以及果汁饮料等产品的热灌装生产。本机采用PLC、变频器、人机界面控制系统。具有变频调速、有瓶自动灌装，无瓶不灌装等先进的控制技术，通过设备上的各种传感器，在触摸屏上可以显示出准确的生产速度和生产数量，生产速度根据用户要求可以在触摸屏上自行设定。该机集冲瓶、灌装、封口为一体。设计科学合理、造型美观、操作维修方便、自动化程度高，是热灌装饮品的首选生产设备。

This machine is used for hot filling production of green tea, black tea, oolong tea and fruit drinks. This machine adopts PLC, inverter and human-machine interface control system. It has advanced control technologies such as variable frequency speed regulation, automatic filling with bottles, and no filling without bottles. Through various sensors on the equipment, it can display the accurate production speed and production quantity on the touch screen. Customer can set the production speed on the touch screen. The machine integrates flushing, filling and sealing. The design is scientific and reasonable, the appearance is beautiful, the operation and maintenance are convenient, and the degree of automation is high. It is the preferred production equipment for hot filling beverages.





Isobaric washing-filling-capping 3-in-1 machine 等压冲瓶灌装旋盖三合一机组

本设备是聚酯瓶含气饮料的专用灌装设备，集冲洗、灌装、封盖于一体。它主要用于汽水、可乐、汽酒、矿泉水等含气饮料的冲洗、灌装和塑料与螺纹盖的封盖。结构合理，操作安全，工作可靠，维护方便。传输采用卡瓶颈技术，变换瓶形无须调整设备高低，只需更换与瓶口、瓶身直径相关的弧形导板、拨轮等件。全不锈钢冲瓶机瓶夹结实耐用，不接触瓶口螺纹部位，避免瓶口二次污染。与物料接触零件采用食品级不锈钢制作，无工艺死角，易清洗。采用气动蝶阀控制物料进液流量，确保灌装精度。开阀机构由气缸驱动，动作准确可靠。高速大流量、高精度灌装阀，灌装速度快，液面准确无液损。封盖头采用磁性恒扭矩装置，确保封盖质量，且不会损坏瓶盖。采用高效的理盖系统，具有完美的喂盖与缺盖保护装置。设有完善的过载保护装置，能有效的保护设备及操作者的安全。

The equipment is used for carbonated soft drink filling with PET bottle. It combines rinsing, filling and capping into one machine. It is mainly applicable for rinsing bottle, filling carbonated water, cola, beer and mineral water and seal the plastic screw cap. The machine has advantages of reasonable structure, safe operation, reliable working and easy maintenance. The bottle transportation adopts neck handling technology, when changing bottle size, no need to adjust machine height, only replace relative parts, such as arc board, thumb etc. The rinsing gripper is in stainless steel structure, does not contact with the bottle neck thread spot, avoids the second pollution for the bottle neck. All the parts which contact with the material directly is made of food grade stainless steel, no dead angle, easy to clean. Use pneumatic butterfly valve to control material flow, which can guarantee the high filling precision. Open valve device is driven by the air cylinder, the action is accurate and reliable. High speed, large flow and high accuracy filling valve make the filling speed fast, the liquid level is stable. The capping heads adopt magnetism permanent torque device, which can guarantee the quality of sealing cap, and also does not damage the cap. Use the high effective cap sorter system, which has perfect cap feeding and cap lacking protection device. Equipped with perfect over-load protection to protect the machine and operator's security effectively.



Glass bottle 3-in-1 filling machine 玻璃瓶三合一灌装机

本设备在一体机中实现冲瓶、灌装、封盖等功能，适用于白酒及其他液体设备的玻璃瓶灌装。采用不锈钢机身，结构紧凑，控制系统完善，操作方便，自动化程度高。凡与物料接触的零件均采用优质304不锈钢制造，无工艺死角，易清洗。本机采用进瓶螺杆分瓶，高速灌装阀灌装，液位准确无液损，确保灌装工艺要求。变频调速，数字显示，无瓶不灌装并设有过载保护装置，卡瓶停机，开机软启动，适用瓶子高度范围广，主要密封件均由进口硅胶制造。灌装阀容易拆卸，清洗方便，是饮料生产厂家首选的理想设备。

This machine has three functions: washing, filling and capping. It is suitable for the white wine and other liquid packed in the glass bottles. The machine body is made of the stainless steel. The structure is stable, the controlling system is complete, the operation is easy and the automation is high. All the contact part is made of high quality of stainless steel 304. There is no technological dead corner, so the whole machine is easy to clean. This machine adopts the screw splitting bottle way to make bottles in. It uses the high speed filling valve to fill, and the liquid level is accurate to make sure the filling technology requirement. The machine also adopts the frequency control and the digital display. If there is no bottle, the machine will not work and there is the overload set to protect the machine. It can fill kinds of height of glass bottle. The main sealing element is made of imported silica gel. The filling valve can be taken down easily and washed. It is the ideal filling machine for different beverage filling manufacturers.



Filling and foil sealing machine 灌装铝箔封口机

本机集灌装、铝箔自动制盖下盖、封口等于一体化塑料瓶灌装封口机，采取气缸封口，它具有独立封口，智能感应、封口时间可控制，整机运行平稳、造型美观大方、使用维修方便、触摸屏操作、变频调速等特点，是饮料、奶制品最理想的灌装封口设备。

The machine set filling, aluminum foil lids making, sealing equal to the integrated plastic bottle filling sealing machine. Adopting cylinder sealing and it has independent sealing, intelligent sensing, sealing time can be controlled, the whole machine running stably, beautiful appearance, easy to use and maintenance, touch screen operation, variable frequency speed, etc. It is the most ideal filling sealing equipment for beverage and dairy products.



Linear filling machine 直线灌装机

该设备适用于食用油，蜂蜜、浓酱、果酱、洗洁精等物料不含颗粒的流体定量灌装。采用直线式输送，由精确流量计输出信号经台湾进口（PLC）反馈到人机界面显示智能全程监控，具有联锁、信号、自测等安全装置；数码调控灌装容量，配套真空回吸等功能先进装置，不拉丝，不滴漏，灌装精度±1g，灌装范围广稳定性好，适用于各种瓶形灌装，调节简单操作方便，微电脑控制，自动化程度高。方便清洗维修，使用寿命长。

The machine is suitable for the quantitative filling of liquid containing particles, such as edible oil, honey, thick sauce, jam, detergent and other materials. With the linear conveyor, by the accurate flow meter output signal from PLC(Taiwan) and feedback to the man-machine interface display intelligent monitoring during the entire process, with safety interlock, signal, the self-test device; digital control filling volume, supporting vacuum suction function of advanced devices, not drawing, no leakage, filling accuracy ± 1g, filling a wide range of stability for in all kinds of bottle shape filling, regulation is simple, the operation is convenient, microcomputer control, degree of automation. Convenient cleaning and maintenance, long service life.





Can filling sealing machine 易拉罐灌装生产线

本机是在消化吸收国内外易拉罐灌装封罐机(封口机)的基础上开发的设备。当空罐经拨轮进入升降托罐盘后,灌装阀和空罐对中,空罐升起并密封,同时自动打开灌装阀的阀门,当灌装液面堵住阀的回气管口时停止灌装。灌好的罐子经钩子链送到封口机头,盖子经送盖器及压头把盖子送到罐口上,当托罐机构升起时,压头压紧罐口,封口轮先预封再实封,罐子封好后被打盖机构的打头推出,然后进入出罐输送。本机采用PLC、变频器、人机界面控制系统。具有变频调速、有罐自动灌装,无罐不灌装等先进的控制技术,通过设备上的各种传感器,在触摸屏上可以显示出准确的生产速度和生产数量,生产速度根据用户要求可以在触摸屏上自行设定。整机具有主电机及其他电器的各种保护,如过载、过压等。同时在触摸屏上会自动显示出相应的各种故障,方便用户查找故障原因。本机电气元件采用国际知名品牌,也可根据客户要求指定品牌。

This machine is exclusive development of equipment based on the digestion and absorption of domestic and foreign cans filling and sealing machine. After empty cans allocated round to enter the lifting supporting cage, filling valve should be alignment with empty cans, empty cans rise and be sealed, open filling valve automatically at the same time. When liquid level filling block valve of the gas nozzle back, then stop filling. Irrigation jar by a hook chain sent to sealing head lid was sent to cover device and pressure head to cover sent to the pot mouth, when the can supporting mechanism rises, pressure head pressing can mouth, pre-sealing and then sealing, jar sealed after being hit cover mechanism starts to launch and into the can transport device. This machine adopts PLC, frequency converter, man-machine interface control system. It with frequency control, automatic filling control technology, through a variety of sensor devices, in touch screen can show the accurate production rate and production quantity, production speed can be set up in touch screen according to the user requirements. The whole machine has a variety of protection of the main motor and other electric appliances, such as overload, over-voltage, etc.. At the same time, on the touch screen will automatically display a variety of faults to facilitate users to find the cause of the fault. This machine electric components adopt international famous brand, also can according to the customer request.



Empty can depalletizer 卸垛机

卸垛机是吸收国外先进技术研制开发的新型机器。适用于不同中大型铝罐、玻璃瓶饮料生产线,部分功能可根据客户实际要求进行更改或增加。该机操作简单,运行平稳,产量大,维修方便。

The unpalletizer is a new type of machine developed by absorbing foreign advanced technology. Suitable for different medium and large aluminum cans, glass bottle beverage production lines, some functions can be changed or added according to customers' actual requirements. The machine has the advantages of simple operation, stable running, large output and convenient maintenance.



Gable top carton filling machine 屋顶盒灌装机

屋顶形包装机因其独特的造型、美观的图案、环保的材质、方便的使用等原因,使该产品档次高、利润大,在琳琅满目液体产品的包装市场突显其特色,也会使企业赚得可观的利润。

屋顶形纸盒包装产品的生产过程较其他任何一种包装的生产都方便易行,其特点:①不需要大的包装物仓库,不需要大笔运输费用,一个纸箱即可装到近千个包装纸盒片。②包装盒不用清洗直接上机,可节省大量水费、电费、人力费、设备费等。③生产车间面积要求不大,建厂费用低。④生产工人需要量少,工资费用低。

Due to its unique shape, beautiful patterns, environmentally friendly materials, and convenient use, the roof-shaped packaging machine makes the product high-grade and profitable. It highlights its characteristics in the packaging market of liquid products, and it also makes the company earn considerable profit.

The production process of roof-shaped carton packaging products is easier than the production of any other packaging. Its characteristics: ①No need for a large packaging warehouse, no need for large shipping costs, a carton can be loaded into nearly a thousand packaging carton sheets. ②The box can be directly loaded on the machine without cleaning, which can save a lot of water, electricity, labor and equipment costs. ③The production workshop area is not required, and the construction cost is low. ④Production workers need less, and wages are low.

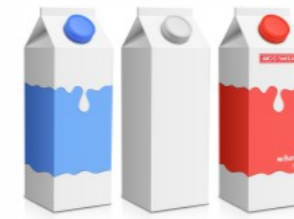



High speed brick aseptic filling machine 高速砖包无菌灌装机

罐装产品

- ◆灌装产品：液态、非粘性产品
- ◆产品种类：纯奶、酸奶、果汁、豆奶、茶饮料等
- ◆供给压力：100~250±10KPa
- ◆供给温度：5-50℃
- ◆保质期：常温25-30℃下，6个月以上
- ◆灌注方式：伺服比例控制阀自动控制灌注管内液位和灌注量
- ◆灌装速度：6000-20000
- ◆砖包规格：125-1000ML之间各种规格[现有的125S, 200S, 250S, 250B, 1000S, 1000SQ(钻型)]

Filling capacity

- ◆Filling product: Liquid, nonstick product
- ◆Product: Pure milk, yoghurt, juice, soymilk, tea, etc
- ◆Pressure supply: 100~250±10KPa
- ◆Temperature supply: 5-50℃
- ◆Quality guarantee period: Under normal temperature of 25-30℃, the guarantee period is above 6 months
- ◆Filling type: Servo proportional control valve controls the liquid level and filling quantity of the filling pipe automatically.
- ◆Filling capacity: 6000-20000
- ◆Packaging size: All kinds of sizes from 125-1000ML (now we have 125S, 200S, 250S, 250B, 1000S, 1000SQ)

包材规格

- ◆包材直径：≤Φ1100mm
- ◆芯轴直径：Φ152mm
- ◆封带直径：Φ230mm
- ◆封带卷芯直径：Φ74mm
- ◆拼接方式：包材、封带不停机自动拼接

Packaging material specification

- ◆Diameter: ≤Φ1100mm
- ◆Core shaft diameter: Φ152mm
- ◆Sealing tape diameter: Φ230mm
- ◆Sealing tape roll core diameter: Φ74mm
- ◆Stitching type: Packaging material and sealing tape stitched automatically without stopping the machine



Automatic aseptic plastic pouch filling machine 全自动无菌软包装机

该机采用全气动结构，PCC智能可编程计算机控制器控制，运行稳定、操作简单、维护成本低。产品不断升级，国内首家推出高速9000型机。

This machine adopts full pneumatic structure, PCC intelligent programmable computer controller, stable operation, simple operation, low maintenance costs. Product upgrades, 9000 China launched the first high-speed machines.





Aseptic bag filling machine 无菌袋灌装机

主材质为食品级304不锈钢材质；机架采用80×80×3mm的304不锈钢方管焊接而成；灌装机采用一键式启动，所有动作的中间环节都有传感器确认，绝对杜绝设备的误动作；无菌灌装腔的温度>95℃，设备才允许灌装，确保产品无菌，灌装室杀菌30min以上才可以灌装；所有的灌装重量，温度设定都可以在触摸屏上修改设定；设备采用流量计或称重方式；设备有独立的采样程序，设备默认口径为1"的袋嘴，灌装精度±1%；法兰连接处含蒸汽保护，电机防护等级为IP54，独立控制系统；

设备说明

无菌灌装机使用蒸汽对袋口、灌装头和灌装室进行三点喷射杀菌，以确保灌装过程的无菌要求；无菌袋袋口杀菌、开启、灌装和封口都在无菌环境下完成；本设备自带无菌室，在和外界隔离的条件下利用机械手自动完成开盖、灌装、计量、关盖等过程；适合植物提取液、水果原汁、果酱、饮料原浆(浆)、乳品等行业的无菌充填灌装；可实现与杀菌机、无菌罐系统联动生产/CIP/SIP。



The main material is food grade 304 stainless steel; The frame is welded with 304 stainless steel square pipes of 80x80x3mm; The filling machine adopts one-button start, all the middle links of the action are confirmed by the sensor, absolutely eliminate the wrong action of the equipment; The temperature of the aseptic filling chamber is >95℃, the equipment allows the filling, to ensure that the product is sterile, and the filling chamber can be filled only after 30 minutes of sterilization; All filling weight and temperature Settings can be modified on the touch screen; The equipment adopts flowmeter or weighing method; The equipment has an independent sampling program, the default aperture of the equipment is 1" bag mouth, the filling accuracy is ±1%; The flange joint contains steam protection, the motor protection grade is IP54, independent control system;

Equipment description

Equipment description: The aseptic filling machine uses steam to sterilize the bag mouth, the filling head and the filling chamber at three points to ensure the aseptic requirements of the filling process; Sterilization, opening, filling and sealing of the bag mouth are completed in a sterile environment; The equipment has its own aseptic room, which can automatically complete the process of opening, filling, measuring and closing the cover by the manipulator under the condition of isolation from the outside world. Suitable for plant extract, fruit juice, jam, beverage paste (pulp), dairy industry aseptic filling; It can realize linkage production with sterilization machine and aseptic tank system /CIP/SIP.



Automatic barreling production line 自动桶装生产线

此自动桶装线是专供水3加仑、5加仑桶装饮用水生产之用。整机集：冲洗、灌装、封盖功能于一体。是矿泉水、蒸馏水、纯净水生产的理想设备。整机采用优质不锈钢，防腐，易清洗。主要电气元件均采用SIEMENS、OMRON产品，气路系统采用进口AirTAC名牌产品。该机结构紧凑，占地厂房小，工作效率高且稳定可靠，自动化程度高。操作工仅需二人，是机电气三位一体的全自动桶装设备。

This Barreled Production Line is composed of bottle washing machine, bottle filling machine and sealing machine into one body especially for the production of drinking water of 3 and 5 gallons. It is an idea filling line to produce mineral water, distilled water and purified water. The whole line is made of superior stainless steel, anti corrosive and easy to clean. Sidemen's electric components are adopted as main components. The world famous product of Air TAC and Omron are introduced in the air circuit systems. The machine is compactly conformed to small occupation of land and high efficiency and reliable and stable quality and high automation. Only two operators are needed for a line, which is wholly automatic barreled equipment with motor, electric unit and air three in one.

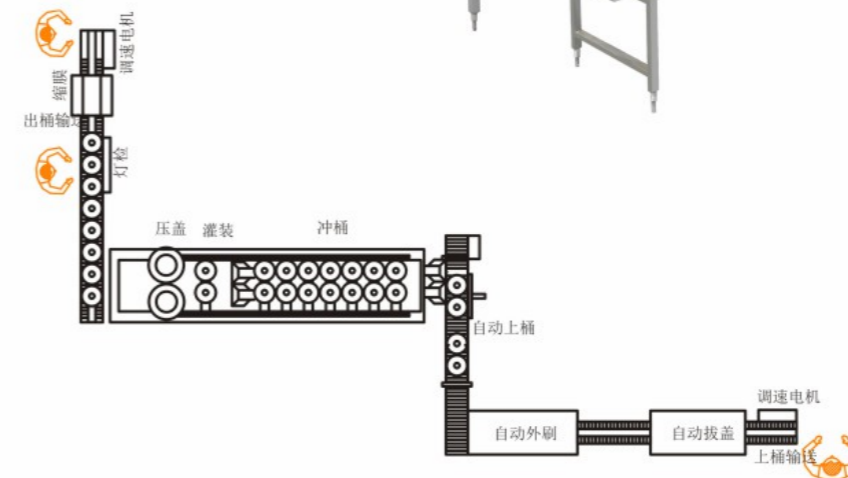



Cup filling sealing machine

杯装灌装封口机

本机集落杯，灌装，吸膜，封口，喷码，出杯于一体机，具有操作简便，性能稳定，易于维护保养。既可以单机使用，也可接入生产流水线使用。该机采用PLC程序控制，造型美观，功能齐全，操作简便，符合国家卫生法的要求，满足标准、规模化生产。

This machine set drop cup, filling, suction film, sealing, spray code, cup output in one machine, with easy operation, stable performance, easy maintenance. It can be used individually or in production lines. The machine adopts PLC program control, beautiful shape, complete function, easy to operate, in line with the requirements of the National Health Law, to meet the standard, large-scale production.

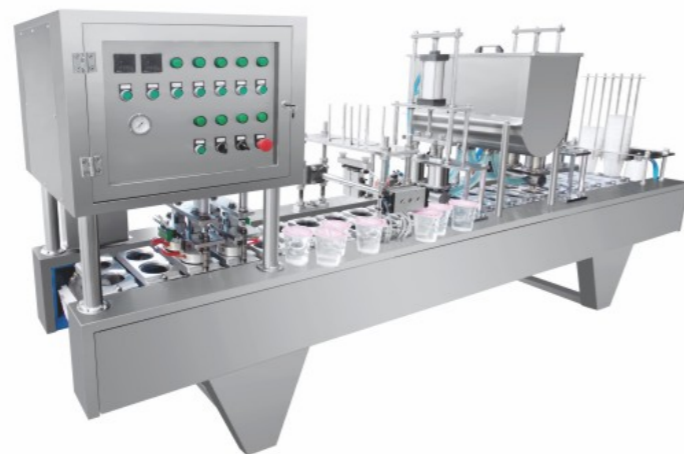

Pouch packaging machine

液体包装机

本机广泛应用于包装水、牛奶、豆浆、酱油、醋等各种液体。全自动完成紫外线杀菌、制袋、日期打印、定量灌装、封袋、分切、计数。热封温度自动控制。

This machine is widely used to packing water, milk, soybean milk, sauce, vinegar and all kinds of liquid. The whole process can be accomplished automatically, such as ultraviolet sterilization, bag figuration, date printing, quantitative filling, sealing, cutting, counting, and so on. The temperature of heat-sealing is controlled automatically.



Sleeve labeling machine

单头/双头套标机

主要技术参数

1. 产量: 1000-15000BPH
2. 标签规格: 0-100mm
3. 瓶和罐的直径: $\Phi 28-125\text{mm}$
4. 标签长度: 30-250mm
5. 标签厚度: $\geq 0.035\text{mm}$
6. 标签材质: pvc/pet/ops

Main technical parameters

1. Capacity: 1000-15000BPH
2. Label norm: 0-100mm
3. Diameter of the bottle and can: $\Phi 28-125\text{mm}$
4. Length of label: 30-250mm
5. The thickness of label: $\geq 0.035\text{mm}$
6. Material of label: pvc/pet/ops





Sticker labeling machine 不干胶贴标机

标头任何角度调整，更适用于不同的产品形状之调节，操作简单方便；

压带分段式垫条，不会因产品的高低而影响个体压力，垫条高分子材料更耐磨；

采用30度丁腈动力胶辑与气缸夹辑三辑定位机构，使产品转动平稳，从而提高贴标精度；

产品定位贴采用光电感应定位，可在产品的任何位置指定精准贴标(定位选型)。

Headers any angle adjustment, more suitable for different product shape of regulation, operation simple and convenient.

Pressure with sectional mat, will not affect the individual by products of high and low pressure, mat of polymer materials is more wear-resisting.

Adopting a three-roller positioning mechanism of 30-degree cyanidebutadiene power rubber roller and cylinder nip roller to make the product rotate smoothly, thereby improving the labeling accuracy.

The product positioning sticker adopts photoelectric induction positioning, which can specify precise labeling at any position of the product (positioning selection).



Hot melt glue labeling machine 热熔胶贴标机

人性化触摸屏，操作简单直观、功能齐全，具有丰富的在线帮助功能。送标系统采用德国高速伺服马达及控制器，保证了高速送标及切标的准确性、稳定性。德国标签色标检测电眼，提高了出标精度。完善的运行保护系统，可实现诸如缺标、漏贴、缺瓶、卡瓶、温度检测、气压不足等停机报警。由于采用旋转式模具定位贴标方式，保证了贴标的封口精度及稳定性能。采用西门子等世界品牌进口电气原件，确保整机的持久稳定及可靠性。

User friendly touch screen, simple and intuitive operation, complete functions, have a wealth of online help function. System of transmitting label adopts German high speed servo motor and controller, to ensure the accuracy and stability of high speed transmitting and cutting label. Perfect running protection system, which can realize shutdown alarms such as lack of label, missing label, lack of bottle, bottle jam, temperature detection, and insufficient air pressure. Adopt rotary mould positioning labeling method, to ensure label seal precision and stable performance. Use the world brand imported electrical components such as Siemens, ensure lasting stability and reliability of the whole machine.

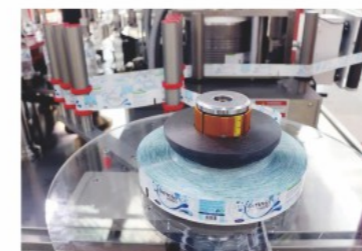



Automatic bottle blowing machine

全自动吹瓶机

特点

1. 机器全自动操作;
2. 专利单通道上胚机构;
3. 采用双排灯管加热, 加热密集, 更加节能;
4. 加热单元每组和每支灯管可调, 采用恒定电压控制;
5. 触模式操作简单方便;
6. 模块化设计拆装便捷;
7. 智能模块化高压吹气组合阀;
8. 采用液压混合驱动开合模;
9. 采用高级米汉纳铸铁的开关模系统。

Characteristic

1. Use double heating oven, heating densed, saving more energy.
2. Automatic feeding, heating, blowing with oir system.
3. Potented preform feeding system for easy and safety.
4. Heating system for each lamp adjustment and constant voltage control system.
5. Touch screen human-machine interface for easy operation.
6. Modular component design for easy maintenance.
7. Compact design for effective usage of floor space.
8. Intelligence flow control with high pressure valve.



Semi-auto bottle blowing machine

半自动吹瓶机

机器优势

1. 采用电脑PLC控制系统, 操作简易;
2. 能源使用效率提高;
3. 人机界面控制, 操作简单;
4. 模块化设计, 换模及维修容易;
5. 能源使用低, 产能提高;
6. 占地面积小。

Machine advantages

1. Adopt PLC control system, easy to operate.
2. Upgrade power efficiency.
3. Simplified operation by HMI control panel.
4. Modular design facilitates maintenance.
5. Save investment and enhance capacity.
6. Minimum space.





Automatic bottle tilting sterilizer 倒瓶杀菌机



连续倒瓶杀菌机是在吸收、消化国外样机的基础上设计而成。主要特点:输送平稳、不会产生抖动或跳动现象;杀菌段物体倒放在杀菌链上、物体倾斜度为 $\leq 93^\circ$ 、确保物体的完整杀菌效果;整机输送流畅、外型美观、噪音小等优点。其线速度: 0-15m/min, 杀菌时间: 25秒-60秒, 杀菌温度 $\leq 98^\circ\text{C}$, 冷却温度 20°C 。

Continuous Bottle Tilting Sterilization chain is designed by absorbing technology of same procedures from foreign model machine. Main characteristic: stable conveying without shaking and jumping. The products are tilting upended on the sterilization chain, of which the lean angle is not more than 93° to ensure full effectiveness. The machine has the advantages of conveying smoothly, beautiful shape and low noise etc. Its conveying speed is 0-15m/min, sterilization time is 25s-60s, sterilization temperature is less than 98°C , cooling time is 20°C .

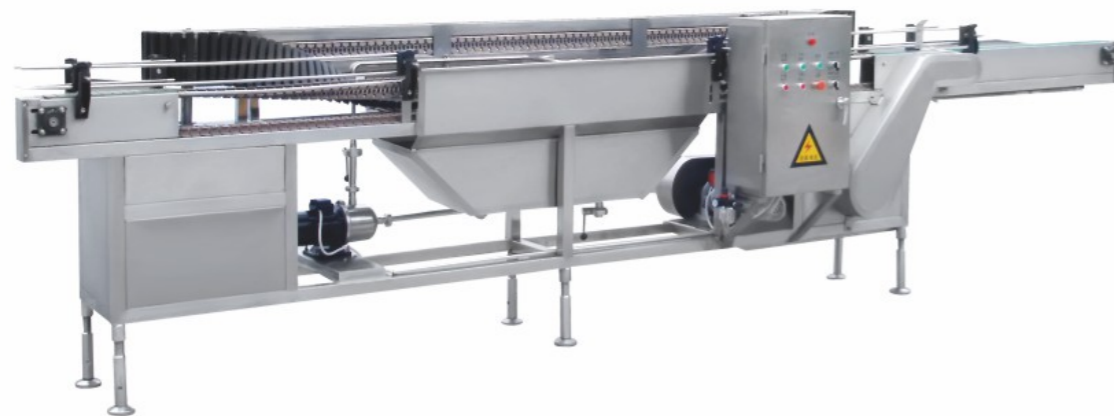

Continuous spraying tunnel pasteurizer 喷淋杀菌机

连续喷淋式杀菌机是在吸收、消化国外样机的基础上设计而成。采用循环温水预热、循环热水杀菌、循环温水预冷, 再用冷却水喷淋冷却, 四段处理形式; 具有杀菌温度自动控制, 杀菌时间无级可调等优点, 能广泛应用于各种瓶装、罐装酸性果汁饮料、电解质饮料、酒类、调味品等产品的杀菌冷却。设备可根据用户提出的杀菌条件及产量要求进行设计。

Continuous spraying sterilizer is designed and made on the basis of absorbing and digesting foreign advanced machine. It adopts warm water to preheat, sterilize with recycling hot water, recycling warm water to precool, and cooling water to cool; It has the advantages of sterilizing temperature automatic control, and adjustable sterilizing time; and can be widely used in sterilizing and cooling of juice beverage, electrolyte beverage, wine, condiments in various bottles and cans. It can be designed and made to the sterilization conditions and production provided by the customer.





Continuous water soaking pasteurizer 水浴杀菌机

本机是消化吸收德国技术同类产品的基础上，全新设计的，专门应用于乳品，饮料，果冻的二次杀菌，整机符合包装产品接触部分全部采用SUS304不锈钢制作，大链板。链轮也采用同种原料，具有抗酸碱，耐腐蚀的作用，水箱由蒸汽加热，蒸汽用量由蒸汽电磁阀自动控制，热水可充分利用，整机设计合理，制造精良，运做稳定，美观大方。

This machine is newly designed on the basis of digesting and absorbing similar products of German technology. It is specially used for the secondary sterilization of dairy products, beverages and jelly. The whole machine is made of SUS304 stainless steel and the large chain plate is used for the contact parts of the packaging products. The sprocket is also made of the same raw materials, which has the functions of acid and alkali resistance and corrosion resistance. The water tank is heated by steam, and the steam consumption is automatically controlled by the steam solenoid valve. The hot water can be fully utilized. The whole machine is designed reasonably, well manufactured, stable in operation and beautiful.



Water spray retort 杀菌釜

全功能杀菌釜适用于各类耐高温包装材料：

1. 塑料容器：PP瓶、HDPE瓶
2. 软袋包装：铝箔袋、透明袋、真空袋、高温蒸煮袋等。
3. 马口铁罐：铝罐及玻璃瓶制品。

The full-function sterilization tank is suitable for all types of high-temperature resistant packaging materials:

1. Plastic containers: PP bottles, HDPE bottles
2. Soft bag packaging: aluminum foil bags, transparent bags, vacuum bags, high-temperature steaming bags, etc.
3. Tinplate cans: aluminum cans and glass bottle products.





Film shrink packing machine

膜包机

矿泉水、饮料、啤酒、白酒、输液药瓶等产品的组合包装，包装无需底托，包装后产品紧固美观。

特点

1. 采用进口PLC程序自动控制，性能稳定，控制精确具有自动输送进料，理瓶、收缩、冷却定型流程的全自动化功能。
2. 薄膜输送采用感应开关控制，可调控送膜长度，减少损耗。
3. 输送电机采用进口变频器控制，实现无级调速。先进的螺旋风循环结构，三层隔热层处理节约能源。

This type of machine suits for beverage, drinking water, beer, wine and infusion bottle, etc. packaging, which can be packed without tray and with a firm and beautiful appearance.

Features

1. Applying imported PLC, which can control the machine automatically, with stable performance, precise control. With the capacity of feeding and sorting bottles, shrinking and cooling shaping automatically.
2. Inductive switch control the feeding of film, which can control the length of film and reduce the consumption.
3. Imported transducer control for the conveyor motor, which can realize stepless speed regulation. Advanced spiral wind circulation structure, three-layer insulation treatment, save energy.



Carton packing machine

装箱机

特点

采用立式储存纸板方式，并可随时补充纸箱板，不需停机；适用于同一时间同种纸箱尺寸包装使用，如需变换纸箱规格，手动调节即可，所需时间1-2分钟；合理化设计，同步吸取成型，摺底与封底一次同步成型；体积轻巧，机件性能精密耐用，运作过程无振动，运转稳固寿命长，效率高；配装刀片防护装置，避免操作时意外刺伤；可单机作业，也可与自动化包装流水线配套使用。

Features

Vertical storage is adopted for storing carton blanks, for which carton blanks can be added at any time without stopping the machine; It's suitable for forming and sealing cartons of the same size. If carton size need to be changed, the operator should adjust the machine manually (finishing in 2-3minutes); It's rationally designed so that the forming, folding and sealing process are accomplished simultaneously; all the parts are precise and durable, without causing any vibration in running. Running steadily with long life; light in weight, high performance and speed.





Palletizer 码垛机

特点

1. 采用侧进箱方式，占地面积小，简化码垛机前的输送系统，整机比机器人码垛节省50%成本。
2. 地位码垛式，国际先进逐层式码垛设计理念，结构更先进，动作更轻便平稳，功耗也较小。
3. 采用PLC程序控制，及变频调速，纸箱输送、排序、堆栈板、实踪输出等可自动化实现；
4. 整机安全性极高及强大的诊断功能，多项安全设计及故障即时显示功能，保障人身安全，维修的快捷和简便。
5. 堆垛方式的调整方便、简单，可在人机界面上进行。故障无需更换堆垛零件即可以完成几种堆垛方式。
6. 可实现纸箱码垛或收缩包装产品的码垛。

Features

1. Cases feeding form side ,save more space, simplify transport system, save 50% Cost than robot.
2. Low level palletizing,Advanced layer-type palletizing design,advanced configuration,running stably and low power consumption.
3. PLC control system and convert for speed control insure that cases transfer,Array, palletizing ,pallet unloading, solid pallet pushing out are automatically.
4. Machine with high security and powerful diagnosis function,malfunction alarm and Guard to insure personal safety.
5. Easily to adjust for Palletizing format by touch screen.No need to change parts for malfunction to finish palletizing.
6. Apply to carton and film packing products palletizing.



Film wrapping machine 缠绕膜机

特点

1. 用蓄电池作动力。全自动缠膜机功率强大且噪音小。
2. 包装自动化，节省空间。全自动缠膜机可以随时移动，这样不仅节省了厂房和仓库的空间，而且方便运输到现场立即开始工作。
3. 快速上膜机构。穿膜迅速方便，效率高。
4. 采用可编程程序控制系统。各项参数均可在控制面板上自动调整，控制面板采用液晶显示、操作简易。

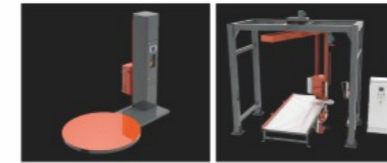

Features

1. Automatic film wrapping machine is powerful and low noise.
2. Packaging automation and space saving. Fully automatic film wrapping machine can be moved at any time, which not only saves space in the plant and warehouse, but also facilitates transport to the site to start working immediately.
3. Quick film loading mechanism. Threading film is quick and easy, with high efficiency.
4. Adopts programmable programme control system. All parameters can be adjusted automatically on the control panel, which adopts liquid crystal display and easy operation.

